

5 VOLT FlashFile™ MEMORY

28F008SA (x8)

- **High-Density Symmetrically-Blocked Architecture**
 - Sixteen 64-Kbyte Blocks
- **Extended Cycling Capability**
 - 100,000 Block Erase Cycles
 - 1.6 Million Block Erase Cycles per Chip
- **Automated Byte Write and Block Erase**
 - Command User Interface
 - Status Register
- **System Performance Enhancements**
 - RY/BY# Status Output
 - Erase Suspend Capability
- **Deep Power-Down Mode**
 - 0.20 μ A I_{CC} Typical
- **Very High-Performance Read**
 - 85 ns Maximum Access Time
- **SRAM-Compatible Write Interface**
- **Hardware Data Protection Feature**
 - Erase/Write Lockout during Power Transitions
- **Industry Standard Packaging**
 - 40-Lead TSOP, 44-Lead PSOP
- **ETOX™ V Nonvolatile Flash Technology**
 - 12 V Byte Write/Block Erase

The 5 Volt FlashFile™ memory 28F008SA's extended cycling, symmetrically blocked architecture, fast access time, write automation and low power consumption provide a more reliable, lower power, lighter weight and higher performance alternative to traditional rotating disk technology. The 28F008SA brings new capabilities to portable computing. Application and operating system software stored in resident flash memory arrays provide instant-on, rapid eXecute-In-Place (XIP) and protection from obsolescence through in-system software updates. Resident software also extends system battery life and increases reliability by reducing disk drive accesses.

For high-density data acquisition applications, the 28F008SA offers a more cost-effective and reliable alternative to SRAM and battery. Traditional high-density embedded applications, such as telecommunications, can take advantage of the 28F008SA's nonvolatility, blocking and minimal system code requirements for flexible firmware and modular software designs.

The 28F008SA is offered in 40-lead TSOP and 44-lead PSOP packages. Pin assignments simplify board layout when integrating multiple devices in a flash memory array or subsystem. This device uses an integrated Command User Interface and state machine for simplified block erasure and byte write. The 28F008SA memory map consists of 16 separately erasable 64-Kbyte blocks.

Intel® 28F008SA employs advanced CMOS circuitry for systems requiring low power consumption and noise immunity. Its 85 ns access time provides superior performance when compared with magnetic storage media. A deep power-down mode lowers power consumption to 1 μ W typical through V_{CC} , crucial in portable computing, handheld instrumentation and other low-power applications. The RP# power control input also provides absolute data protection during system power-up/down.

Manufactured on Intel® 0.4 micron ETOX V process technology, the 28F008SA provides the highest levels of quality, reliability and cost-effectiveness.

NOTE: This document formerly known as *28F008SA 8-Mbit (1-Mbit x 8) FlashFile™ Memory*.

Information in this document is provided in connection with Intel products. No license, express or implied, by estoppel or otherwise, to any intellectual property rights is granted by this document. Except as provided in Intel's Terms and Conditions of Sale for such products, Intel assumes no liability whatsoever, and Intel disclaims any express or implied warranty, relating to sale and/or use of Intel products including liability or warranties relating to fitness for a particular purpose, merchantability, or infringement of any patent, copyright or other intellectual property right. Intel products are not intended for use in medical, life saving, or life sustaining applications.

Intel may make changes to specifications and product descriptions at any time, without notice.

The 28F008SA may contain design defects or errors known as errata which may cause the product to deviate from published specifications. Current characterized errata are available on request.

Contact your local Intel sales office or your distributor to obtain the latest specifications and before placing your product order.

Copies of documents which have an ordering number and are referenced in this document, or other Intel literature, may be obtained from:

Intel Corporation
P.O. Box 5937
Denver, CO 80217-9808

or call 1-800-548-4725
or visit Intel's website at <http://www.intel.com>

COPYRIGHT © INTEL CORPORATION 1997, 1998

CG-041493

*Third-party brands and names are the property of their respective owners



CONTENTS

PAGE	PAGE
1.0 PRODUCT OVERVIEW	5
2.0 PRINCIPLES OF OPERATION.....	10
2.1 Command User Interface and Write Automation	11
2.2 Data Protection.....	11
3.0 BUS OPERATION	11
3.1 Read.....	11
3.2 Output Disable.....	11
3.3 Standby	11
3.4 Deep Power-Down.....	12
3.5 Intelligent Identifier Operation	12
3.6 Write.....	13
4.0 COMMAND DEFINITIONS.....	13
4.1 Read Array Command	13
4.2 Intelligent Identifier Command	15
4.3 Read Status Register Command	15
4.4 Clear Status Register Command	15
4.5 Erase Setup/Erase Confirm Commands	15
4.6 Erase Suspend/Erase Resume Commands	15
4.7 Byte Write Setup/Write Commands	16
5.0 EXTENDED BLOCK ERASE/BYTE WRITE CYCLING	16
6.0 AUTOMATED BYTE WRITE.....	16
7.0 AUTOMATED BLOCK ERASE.....	16
8.0 DESIGN CONSIDERATIONS.....	17
8.1 Three-Line Output Control.....	17
8.2 RY/BY# and Byte Write/Block Erase Polling.....	17
8.3 Power Supply Decoupling	17
8.4 V _{PP} Trace on Printed Circuit Boards	22
8.5 V _{CC} , V _{PP} , RP# Transitions and the Command/Status Registers	22
8.6 Power Up/Down Protection	22
8.7 Power Dissipation	22
9.0 ELECTRICAL SPECIFICATIONS	23
9.1 Absolute Maximum Ratings	23
9.2 Operating Conditions	23
9.3 Capacitance	23
9.4 DC Characteristics	24
9.5 Extended Temperature Operating Conditions.....	25
9.6 DC Characteristics—Extended Temperature Operation	26
9.7 AC Characteristics—Read-Only Operations	29
9.8 AC Characteristics—Read-Only Operations— Extended Temperature Operation	30
9.9 AC Characteristics—Write Operations	33
9.10 Block Erase and Byte Write Performance	34
9.11 AC Characteristics—Write Operations— Extended Temperature Operation	35
9.12 Block Erase and Byte Write Performance— Extended Temperature Operation	36
9.13 Alternative CE#-Controlled Writes.....	38
9.14 Alternative CE#-Controlled Writes— Extended Temperature Operation	40
10.0 ORDERING INFORMATION	42
11.0 ADDITIONAL INFORMATION.....	42

REVISION HISTORY

Number	Description
-002	Revised from Advanced Information to Preliminary Modified Erase Suspend Flowchart Removed -90 speed bin Integrated -90 characteristics into -85 speed bin Combined V_{PP} Standby current and V_{PP} Read current into one V_{PP} Standby current spec with two test conditions (DC Characteristics table) Lowered V_{LKO} from 2.2 V to 2.0 V.
-004	PWD renamed to RP# for JEDEC standardization compatibility. Changed I_{PPS} Standby current spec from $\pm 10 \mu A$ to $\pm 15 \mu A$ in DC Characteristics table.
-005	Added Extended Temperature Specs for 28F008SA Added I_{PPR} Spec Corrected I_{PPS} Spec Type Added V_{OHZ} (Output High Voltage—CMOS) Spec Added Byte Write Time Spec
-006	Minor changes throughout document. Added reset specifications. All components used prior to the publication date of this datasheet are not affected by the new specification. Only devices used after this date must adhere to this new specification.
-007	Removed references to reverse pinout throughout document. Added section numbers.
-008	Changed document title from <i>28F008SA 8-Mbit (1-Mbit x 8) FlashFile™ Memory</i> .

1.0 PRODUCT OVERVIEW

The 28F008SA is a high-performance 8-Mbit (8,388,608 bit) memory organized as 1 Mbyte (1,048,576 bytes) of 8 bits each. Sixteen 64-Kbyte (65,536 byte) blocks are included on the 28F008SA. A memory map is shown in Figure 5 of this specification. A block erase operation erases one of the sixteen blocks of memory in typically 1.6 seconds, independent of the remaining blocks. Each block can be independently erased and written 100,000 cycles. Erase suspend mode allows system software to suspend block erase to read data or execute code from any other block of the 28F008SA.

The 28F008SA is available in the 40-lead TSOP (Thin Small Outline Package, 1.2 mm thick) and 44-lead PSOP (Plastic Small Outline) packages. Pinouts are shown in Figures 2 and 3 of this specification.

The Command User Interface (CUI) serves as the interface between the microprocessor or microcontroller and the internal operation of the 28F008SA.

Byte Write and Block Erase Automation allow byte write and block erase operations to be executed using a two-write command sequence to the CUI. The internal Write State Machine (WSM) automatically executes the algorithms and timings necessary for byte write and block erase operations, including verifications, thereby unburdening the microprocessor or microcontroller. Writing of memory data is performed in byte increments typically within 9 μ s—an 80% improvement over current flash memory products. I_{PP} byte write and block erase currents are 10 mA typical, 30 mA maximum. V_{PP} byte write and block erase voltage is 11.4 V to 12.6 V.

The status register indicates the status of the WSM and when the WSM successfully completes the desired byte write or block erase operation.

The RY/BY# output gives an additional indicator of WSM activity, providing capability for both hardware signal of status (versus software polling) and status masking (interrupt masking for background erase, for example). Status polling using RY/BY# minimizes both CPU overhead and system power consumption. When low, RY/BY# indicates that the WSM is performing a block erase or byte write operation. RY/BY# high indicates that the WSM is ready for new commands, block erase is suspended or the device is in deep power-down mode.

Maximum access time is 85 ns (t_{ACC}) over the commercial temperature range (0 °C to +70 °C) and over V_{CC} supply voltage range (4.5 V to 5.5 V and 4.75 V to 5.25 V). I_{CC} active current (CMOS Read) is 20 mA typical, 35 mA maximum at 8 MHz.

When the CE# and RP# pins are at V_{CC} , the I_{CC} CMOS standby mode is enabled.

A deep power-down mode is enabled when the RP# pin is at GND, minimizing power consumption and providing write protection. I_{CC} current in deep power-down is 0.20 μ A typical. Reset time of 400 ns is required from RP# switching high until outputs are valid to read attempts. Equivalently, the device has a wake time of 1 μ s from RP# high until writes to the CUI are recognized by the 28F008SA. With RP# at GND, the WSM is reset and the status register is cleared.

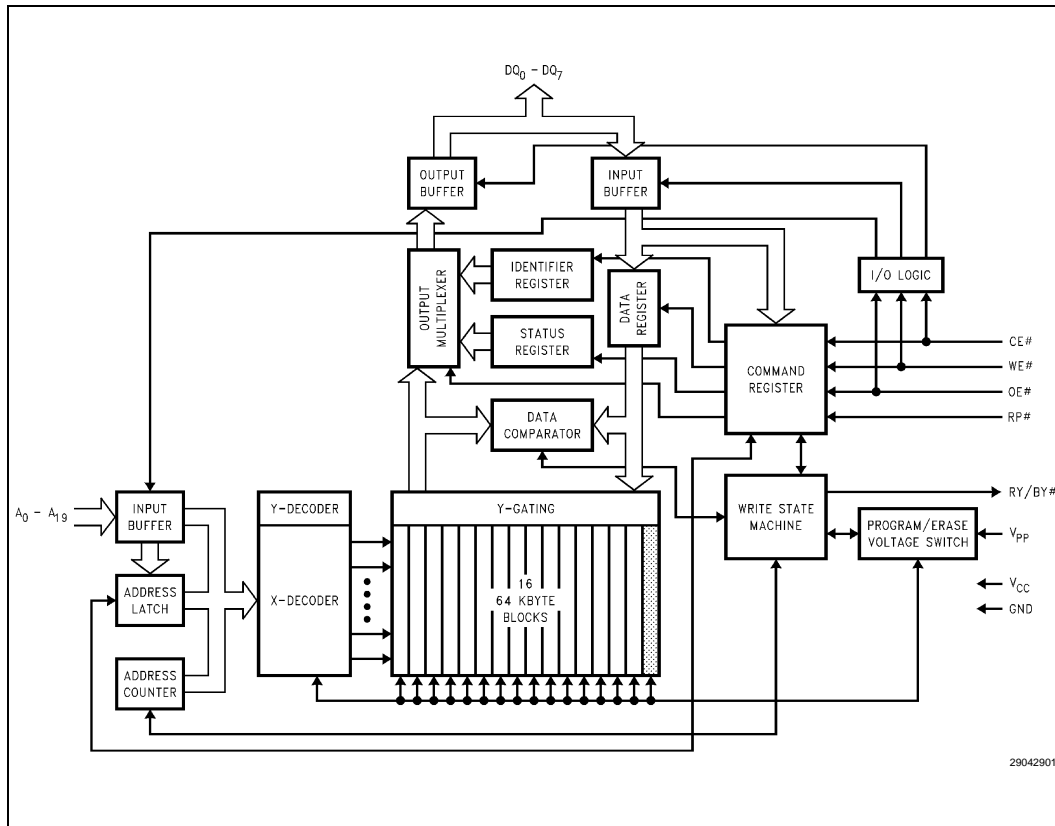

Figure 1. Block Diagram

Table 1. Pin Descriptions

Symbol	Type	Name and Function
A ₀ –A ₁₉	INPUT	ADDRESS INPUTS for memory addresses. Addresses are internally latched during a write cycle.
DQ ₀ –DQ ₇	INPUT/OUTPUT	DATA INPUT/OUTPUTS: Inputs data and commands during CUI write cycles; outputs data during memory array, status register and Identifier read cycles. The data pins are active high and float to tri-state off when the chip is deselected or the outputs are disabled. Data is internally latched during a write cycle.
CE#	INPUT	CHIP ENABLE: Activates the device's control logic, input buffers, decoders, and sense amplifiers. CE# is active low; CE# high deselects the memory device and reduces power consumption to standby levels.
RP#	INPUT	RESET/DEEP POWER-DOWN: Puts the device in deep power-down mode. RP# is active low; RP# high gates normal operation. RP# also locks out block erase or byte write operations when active low, providing data protection during power transitions. RP# active resets internal automation. Exit from deep power-down sets device to read-array mode.
OE#	INPUT	OUTPUT ENABLE: Gates the device's outputs through the data buffers during a read cycle. OE# is active low.
WE#	INPUT	WRITE ENABLE: Controls writes to the CUI and array blocks. WE# is active low. Addresses and data are latched on the rising edge of the WE# pulse.
RY/BY#	OUTPUT	READY/BUSY#: Indicates the status of the internal Write State Machine. When low, it indicates that the WSM is performing a block erase or byte write operation. RY/BY# high indicates that the WSM is ready for new commands, block erase is suspended or the device is in deep power-down mode. RY/BY# is always active and does NOT float to tri-state off when the chip is deselected or data outputs are disabled.
V _{PP}		BLOCK ERASE/BYTE WRITE POWER SUPPLY for erasing blocks of the array or writing bytes of each block. NOTE: With V _{PP} < V _{PPLMAX} , memory contents cannot be altered.
V _{CC}		DEVICE POWER SUPPLY (5 V ±10%, 5 V ±5%)
GND		GROUND

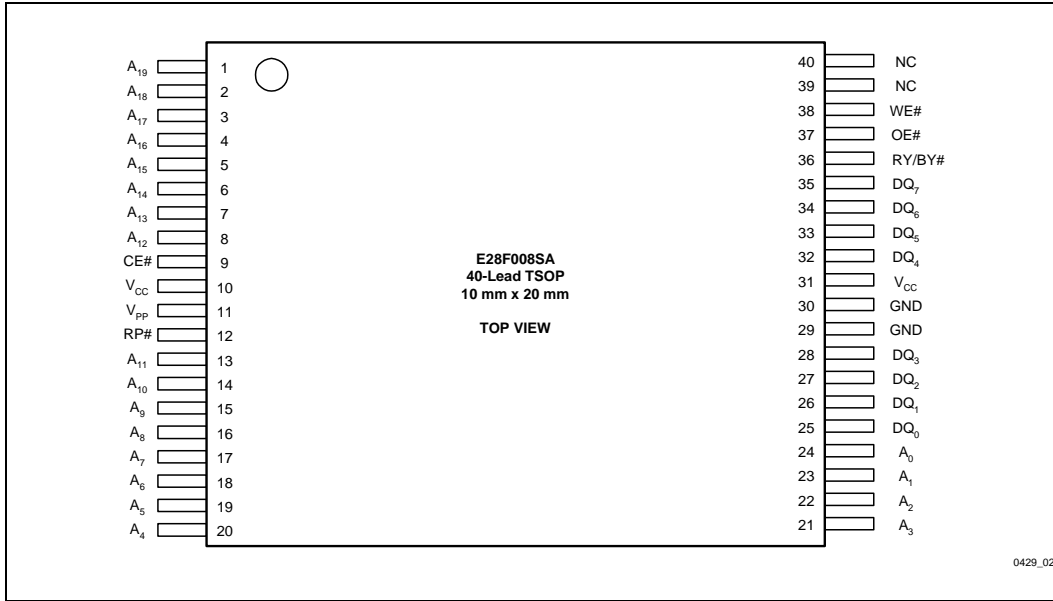

Figure 2. TSOP Lead Configurations

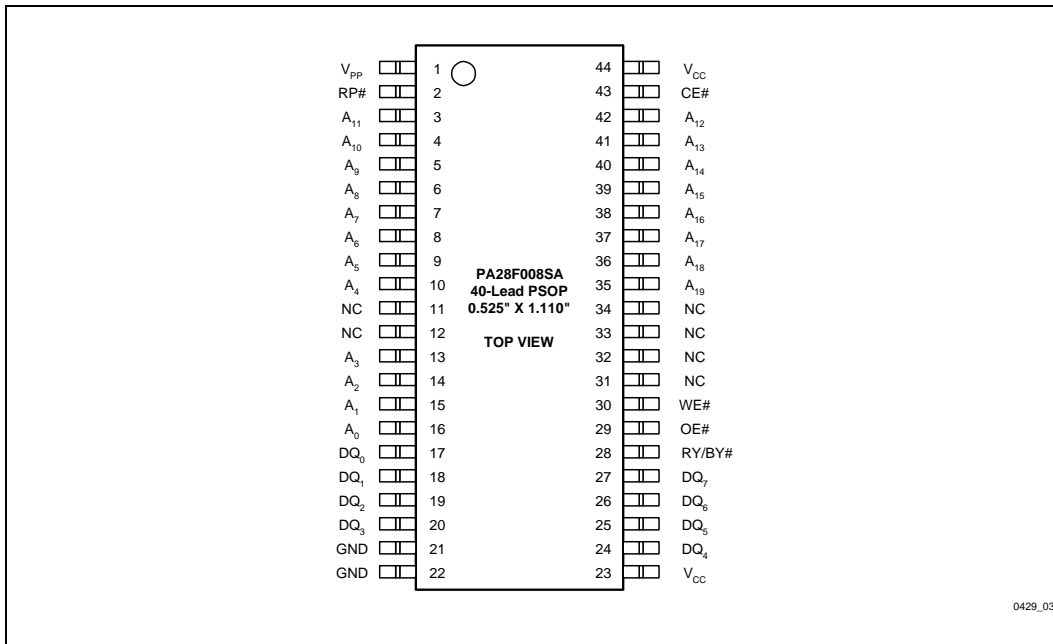

Figure 3. PSOP Lead Configuration

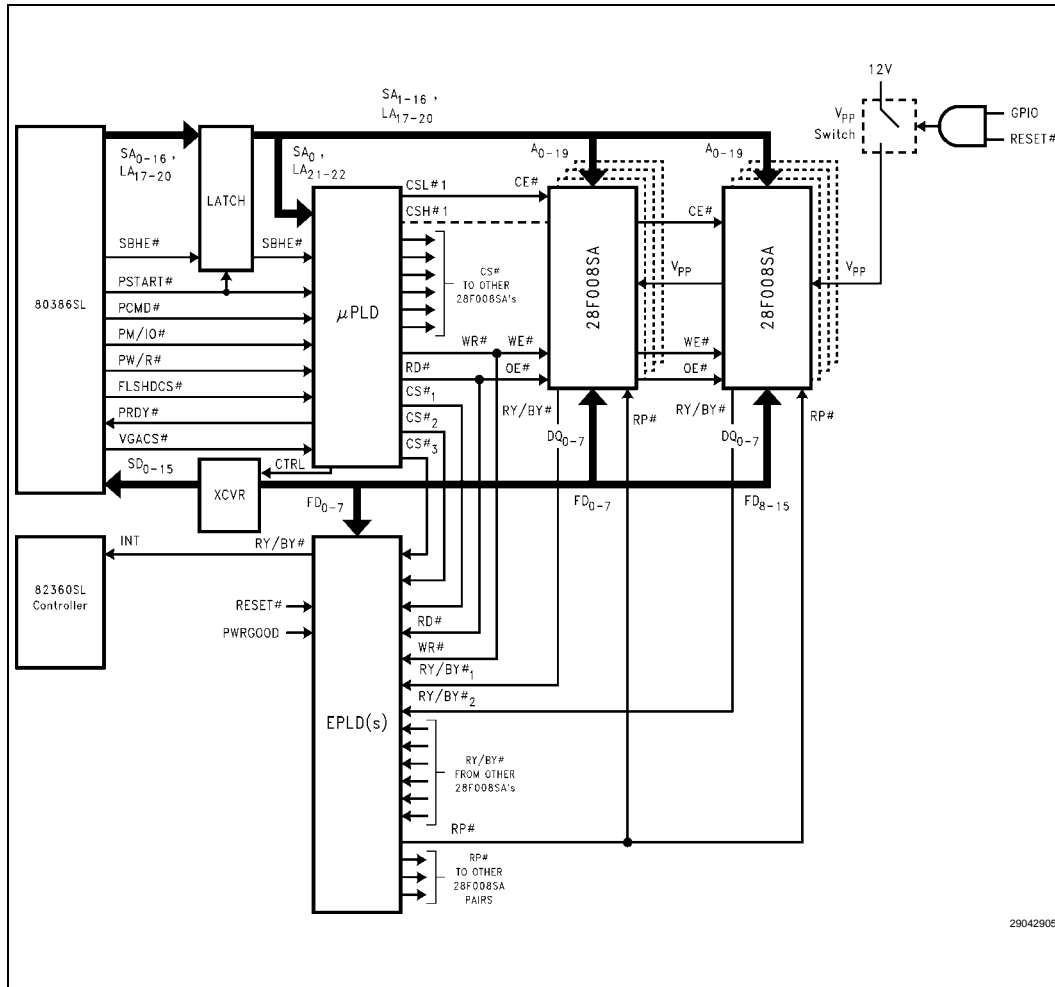

Figure 4. 28F008SA Array Interface to Intel386SL Microprocessor Superset through PI Bus (Including RY/BY# Masking and Selective Power-Down), for DRAM Backup during System SUSPEND, Resident O/S and Applications and Motherboard Solid-State Disk.

2.0 PRINCIPLES OF OPERATION

The 28F008SA includes on-chip write automation to manage write and erase functions. The Write State Machine (WSM) allows for 100% TTL-level control inputs, fixed power supplies during block erasure and byte write, and minimal processor overhead with RAM-like interface timings.

After initial device power-up, or after return from deep power-down mode (see *Bus Operations*), the 28F008SA functions as a read-only memory. Manipulation of external memory-control pins allow array read, standby and output disable operations. Both status register and intelligent identifiers can also be accessed through the CUI when $V_{PP} = V_{PPL}$.

This same subset of operations is also available when high voltage is applied to the V_{PP} pin. In addition, high voltage on V_{PP} enables successful block erasure and byte writing of the device. All functions associated with altering memory contents—byte write, block erase, status and intelligent identifier—are accessed via the CUI and verified through the status register.

Commands are written using standard microprocessor write timings. CUI contents serve as input to the WSM, which controls the block erase and byte write circuitry. Write cycles also internally latch addresses and data needed for byte write or block erase operations. With the appropriate command written to the register, standard microprocessor read timings output array data, access the intelligent identifier codes, or output byte write and block erase status for verification.

Interface software to initiate and poll progress of internal byte write and block erase can be stored in any of the 28F008SA blocks. This code is copied to, and executed from, system RAM during actual flash memory update. After successful completion of byte write and/or block erase, code/data reads from the 28F008SA are again possible via the Read Array command. Erase suspend/resume capability allows system software to suspend block erase to read data and execute code from any other block.

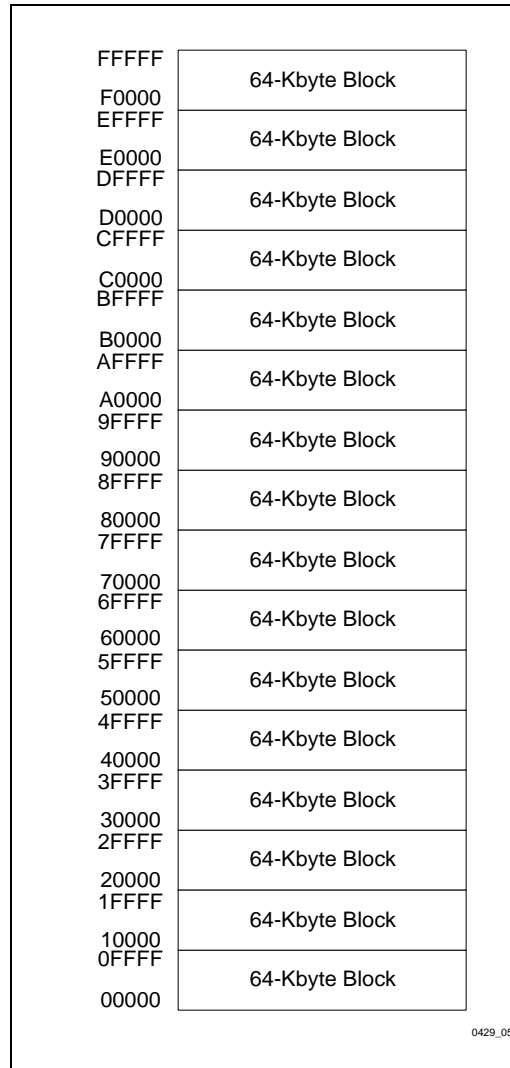

Figure 5. Memory Map

2.1 Command User Interface and Write Automation

An on-chip state machine controls block erase and byte write, freeing the system processor for other tasks. After receiving the Erase Setup and Erase Confirm commands, the state machine controls block pre-conditioning and erase, returning progress via the status register and RY/BY# output. Byte write is similarly controlled, after destination address and expected data are supplied. The program and erase algorithms of past Intel® Flash memories are now regulated by the state machine, including pulse repetition where required and internal verification and margining of data.

2.2 Data Protection

Depending on the application, the system designer may choose to make the V_{PP} power supply switchable (available only when memory byte writes/block erases are required) or hardwired to V_{PPH} . When $V_{PP} = V_{PPL}$, memory contents cannot be altered. The 28F008SA CUI architecture provides protection from unwanted byte write or block erase operations even when high voltage is applied to V_{PP} . Additionally, all functions are disabled whenever V_{CC} is below the write lockout voltage V_{LKO} , or when RP# is at V_{IL} . The 28F008SA accommodates either design practice and encourages optimization of the processor-memory interface.

The two-step byte write/block erase CUI write sequence provides additional software write protection.

3.0 BUS OPERATION

Flash memory reads, erases and writes in-system via the local CPU. All bus cycles to or from the flash memory conform to standard microprocessor bus cycles.

3.1 Read

The 28F008SA has three read modes. The memory can be read from any of its blocks, and information can be read from the intelligent identifier or status register. V_{PP} can be at either V_{PPL} or V_{PPH} .

The first task is to write the appropriate read mode command to the CUI (array, intelligent identifier, or status register). The 28F008SA automatically resets to read array mode upon initial device power-up or after exit from deep power-down. The 28F008SA has four control pins, two of which must be logically active to obtain data at the outputs. Chip Enable (CE#) is the device selection control, and when active enables the selected memory device. Output Enable (OE#) is the data input/output (DQ₀–DQ₇) direction control, and when active drives data from the selected memory onto the I/O bus. RP# and WE# must also be at V_{IH} . Figure 13 illustrates read bus cycle waveforms.

3.2 Output Disable

With OE# at a logic-high level (V_{IH}), the device outputs are disabled. Output pins (DQ₀–DQ₇) are placed in a high-impedance state.

3.3 Standby

CE# at a logic-high level (V_{IH}) places the 28F008SA in standby mode. Standby operation disables much of the 28F008SA's circuitry and substantially reduces device power consumption. The outputs (DQ₀–DQ₇) are placed in a high-impedance state independent of the status of OE#. If the 28F008SA is deselected during block erase or byte write, the device will continue functioning and consuming normal active power until the operation completes.

Table 2. Bus Operations

Mode	Notes	RP#	CE#	OE#	WE#	A ₀	V _{PP}	DQ ₀₋₇	RY/BY#
Read	1, 2, 3	V _{IH}	V _{IL}	V _{IL}	V _{IH}	X	X	D _{OUT}	X
Output Disable	1, 2, 3	V _{IH}	V _{IL}	V _{IH}	V _{IH}	X	X	High Z	X
Standby	1, 2, 3	V _{IH}	V _{IH}	X	X	X	X	High Z	X
Deep Power-Down	1, 2	V _{IL}	X	X	X	X	X	High Z	V _{OH}
Intelligent Identifier (Mfr)	1, 2	V _{IH}	V _{IL}	V _{IL}	V _{IH}	V _{IL}	X	89H	V _{OH}
Intelligent Identifier (Device)	1, 2	V _{IH}	V _{IL}	V _{IL}	V _{IH}	V _{IH}	X	A2H	V _{OH}
Write	1,2,3,4,5	V _{IH}	V _{IL}	V _{IH}	V _{IL}	X	X	D _{IN}	X

NOTES:

1. Refer to *DC Characteristics*. When V_{PP} = V_{PPL}, memory contents can be read but not written or erased.
2. X can be V_{IL} or V_{IH} for control pins and addresses, and V_{PPL} or V_{PPH} for V_{PP}. See *DC Characteristics* for V_{PPL} and V_{PPH} voltages.
3. RY/BY# is V_{OL} when the Write State Machine is executing internal block erase or byte write algorithms. It is V_{OH} when the WSM is not busy, in erase suspend mode or deep power-down mode.
4. Command writes involving block erase or byte write are only successfully executed when V_{PP} = V_{PPH}.
5. Refer to Table 3 for valid D_{IN} during a write operation.

3.4 Deep Power-Down

The 28F008SA offers a deep power-down feature, entered when RP# is at V_{IL}. Current draw through V_{CC} is 0.20 μA typical in deep power-down mode, with current draw through V_{PP} typically 0.1 μA. During read modes, RP#-low deselects the memory, places output drivers in a high-impedance state and turns off all internal circuits. The 28F008SA requires time t_{PHQV} (see *AC Characteristics-Read-Only Operations*) after return from power-down until initial memory access outputs are valid. After this wakeup interval, normal operation is restored. The CUI is reset to Read Array, and the upper 5 bits of the status register are cleared to value 10000, upon return to normal operation.

During block erase, program or lock-bit configuration, RP#-low will abort the operation. RY/BY# remains low until the reset operation is complete. Memory contents being altered are no longer valid; the data may be partially erased or written. Time t_{PHWL} is required after RP# goes to logic-high (V_{IH}) before another command can be written.

This use of RP# during system reset is important with automated write/erase devices. When the system comes out of reset it expects to read from the flash memory. Automated flash memories provide status information when accessed during write/erase modes. If a CPU reset occurs with no flash memory reset, proper CPU initialization would not occur because the flash memory would be providing the status information instead of array data. Intel's Flash memories allow proper CPU initialization following a system reset through the use of the RP# input. In this application RP# is controlled by the same RESET# signal that resets the system CPU.

3.5 Intelligent Identifier Operation

The intelligent identifier operation outputs the manufacturer code, 89H; and the device code, A2H for the 28F008SA. The system CPU can then automatically match the device with its proper block erase and byte write algorithms.

The manufacturer- and device-codes are read via the CUI. Following a write of 90H to the CUI, a read from address location 00000H outputs the manufacturer code (89H). A read from address 00001H outputs the device code (A2H). It is not necessary to have high voltage applied to V_{PP} to read the intelligent identifiers from the CUI.

3.6 Write

Writes to the CUI enable reading of device data and Intelligent Identifiers. They also control inspection and clearing of the status register. Additionally, when $V_{PP} = V_{PPH}$, the CUI controls block erasure and byte write. The contents of the interface register serve as input to the internal state machine.

The CUI itself does not occupy an addressable memory location. The interface register is a latch used to store the command and address and data information needed to execute the command. Erase Setup and Erase Confirm commands require both appropriate command data and an address within the block to be erased. The Byte Write Setup command requires both appropriate command data and the address of the location to be written, while the Byte Write command consists of the data to be written and the address of the location to be written.

The CUI is written by bringing $WE\#$ to a logic-low level (V_{IL}) while $CE\#$ is low. Addresses and data are latched on the rising edge of $WE\#$. Standard microprocessor write timings are used.

Refer to *AC Write Characteristics* and the *AC Waveforms for Write Operations*, Figure 15, for specific timing parameters.

4.0 COMMAND DEFINITIONS

When V_{PPL} is applied to the V_{PP} pin, read operations from the status register, intelligent identifiers, or array blocks are enabled. Placing V_{PPH} on V_{PP} enables successful byte write and block erase operations as well.

Device operations are selected by writing specific commands into the CUI. Table 3 defines the 28F008SA commands.

4.1 Read Array Command

Upon initial device power-up and after exit from deep power-down mode, the 28F008SA defaults to read array mode. This operation is also initiated by writing FFH into the CUI. Microprocessor read cycles retrieve array data. The device remains enabled for reads until the CUI contents are altered. Once the internal WSM has started a block erase or byte write operation, the device will not recognize the Read Array command, until the WSM has completed its operation. The Read Array command is functional when $V_{PP} = V_{PPL}$ or V_{PPH} .

Table 3. Command Definitions

Command	Bus Cycles Req'd	Notes	First Bus Cycle			Second Bus Cycle		
			Oper ⁽¹⁾	Addr ⁽²⁾	Data ⁽³⁾	Oper ⁽¹⁾	Addr ⁽²⁾	Data ⁽³⁾
Read Array/Reset	1		Write	X	FFH			
Intelligent Identifier	3	4	Write	X	90H	Read	IA	IID
Read Status Register	2		Write	X	70H	Read	X	SRD
Clear Status Register	1		Write	X	50H			
Erase Setup/Erase Confirm	2		Write	BA	20H	Write	BA	D0H
Erase Suspend/Erase Resume	2		Write	X	B0H	Write	X	D0H
Byte Write Setup/Write	2	5	Write	WA	40H	Write	WA	WD
Alternate Byte Write Setup/Write	2	5	Write	WA	10H	Write	WA	WD

NOTES:

1. Bus operations are defined in Table 2.
2. IA = Identifier Address: 00H for manufacturer code, 01H for device code.
BA = Address within the block being erased.
WA = Address of memory location to be written.
3. SRD = Data read from status register. See Table 4 for a description of the status register bits.
WD = Data to be written at location WA. Data is latched on the rising edge of WE#.
IID = Data read from Intelligent Identifiers.
4. Following the Intelligent Identifier command, two read operations access manufacture and device codes.
5. Either 40H or 10H are recognized by the WSM as the Byte Write Setup command.
6. Commands other than those shown above are reserved by Intel for future device implementations and should not be used.

4.2 Intelligent Identifier Command

The 28F008SA contains an intelligent identifier operation, initiated by writing 90H into the CUI. Following the command write, a read cycle from address 00000H retrieves the manufacturer code of 89H. A read cycle from address 00001H returns the device code of A2H. To terminate the operation, it is necessary to write another valid command into the register. Like the Read Array command, the Intelligent Identifier command is functional when $V_{PP} = V_{PPL}$ or V_{PPH} .

4.3 Read Status Register Command

The 28F008SA contains a status register which may be read to determine when a byte write or block erase operation is complete, and whether that operation completed successfully. The status register may be read at any time by writing the Read Status Register command (70H) to the CUI. After writing this command, all subsequent read operations output data from the status register, until another valid command is written to the CUI. The contents of the status register are latched on the falling edge of OE# or CE#, whichever occurs last in the read cycle. OE# or CE# must be toggled to V_{IH} before further reads to update the status register latch. The Read Status Register command functions when $V_{PP} = V_{PPL}$ or V_{PPH} .

4.4 Clear Status Register Command

The erase status and byte write status bits are set to "1"s by the Write State Machine and can only be reset by the Clear Status Register command. These bits indicate various failure conditions (see Table 4). By allowing system software to control the resetting of these bits, several operations may be performed (such as cumulatively writing several bytes or erasing multiple blocks in sequence). The status register may then be polled to determine if an error occurred during that sequence. This adds flexibility to the way the device may be used.

Additionally, the V_{PP} status bit (SR.3) **must** be reset by system software before further byte writes or block erases are attempted. To clear the Status Register, the Clear Status Register command (50H) is written to the CUI. The Clear Status Register command is functional when $V_{PP} = V_{PPL}$ or V_{PPH} .

4.5 Erase Setup/Erase Confirm Commands

Erase is executed one block at a time, initiated by a two-cycle command sequence. An Erase Setup command (20H) is first written to the CUI, followed by the Erase Confirm command (D0H). These commands require both appropriate sequencing and an address within the block to be erased to FFH. Block preconditioning, erase and verify are all handled internally by the WSM, invisible to the system. After the two-command erase sequence is written to it, the 28F008SA automatically outputs status register data when read (see Figure 6; *Automated Block Erase Flowchart*). The CPU can detect the completion of the erase event by analyzing the output of the RY/BY# pin, or the WSM status bit of the status register.

When erase is completed, the erase status bit should be checked. If erase error is detected, the status register should be cleared. The CUI remains in read status register mode until further commands are issued to it.

This two-step sequence of set-up followed by execution ensures that memory contents are not accidentally erased. Also, reliable block erasure can only occur when $V_{PP} = V_{PPH}$. In the absence of this high voltage, memory contents are protected against erasure. If block erase is attempted while $V_{PP} = V_{PPL}$, the V_{PP} status bit will be set to "1." Erase attempts while $V_{PPL} < V_{PP} < V_{PPH}$ produce spurious results and should not be attempted.

4.6 Erase Suspend/Erase Resume Commands

The Erase Suspend command allows block erase interruption in order to read data from another block of memory. Once the erase process starts, writing the erase suspend command (B0H) to the CUI requests that the WSM suspend the erase sequence at a predetermined point in the erase algorithm. The 28F008SA continues to output status register data when read, after the Erase Suspend command is written to it. Polling the WSM status and erase suspend status bits will determine when the erase operation has been suspended (both will be set to "1"). RY/BY# will also transition to V_{OH} .

At this point, a Read Array command can be written to the CUI to read data from blocks other than that which is suspended. The only other valid commands at this time are Read Status Register (70H) and Erase Resume (D0H), at which time the WSM will continue with the erase process. The erase suspend status and WSM status bits of the status register will be automatically cleared and RY/BY# will return to V_{OL} . After the Erase Resume command is written to it, the 28F008SA automatically outputs status register data when read (see Figure 7; *Erase Suspend/Resume Flowchart*). V_{PP} must remain at V_{PPH} while the 28F008SA is in Erase Suspend.

4.7 Byte Write Setup/Write Commands (40H or 10H)

Byte write is executed by a two-command sequence. The Byte Write Setup command (40H or 10H) is written to the CUI, followed by a second write specifying the address and data (latched on the rising edge of WE#) to be written. The WSM then takes over, controlling the byte write and write verify algorithms internally. After the two-command byte write sequence is written to it, the 28F008SA automatically outputs status register data when read (see Figure 8; *Automated Byte Write Flowchart*). The CPU can detect the completion of the byte write event by analyzing the output of the RY/BY# pin, or the WSM status bit of the status register. Only the Read Status Register command is valid while byte write is active.

When byte write is complete, the byte write status bit should be checked. If byte write error is detected, the status register should be cleared. The internal WSM verify only detects errors for "1"s that do not successfully write to "0"s. The CUI remains in read status register mode until further commands are issued to it. If byte write is attempted while $V_{PP} = V_{PPL}$, the V_{PP} status bit will be set to "1." Byte write attempts while $V_{PPL} < V_{PP} < V_{PPH}$ produce spurious results and should not be attempted.

5.0 EXTENDED BLOCK ERASE/BYTE WRITE CYCLING

Intel has designed extended cycling capability into its ETOX flash memory technologies. The 28F008SA is designed for 100,000 byte write/block erase cycles on each of the sixteen 64-Kbyte blocks. Low electric fields, advanced oxides and minimal oxide area per cell subjected to the

tunneling electric field combine to greatly reduce oxide stress and the probability of failure. A 20-Mbyte solid-state drive using an array of 28F008SAs has a MTBF (Mean Time Between Failure) of 33.3 million hours¹, over 600 times more reliable than equivalent rotating disk technology.

6.0 AUTOMATED BYTE WRITE

The 28F008SA integrates the Quick-Pulse programming algorithm of prior Intel Flash devices on-chip, using the CUI, status register and WSM. On-chip integration dramatically simplifies system software and provides processor interface timings to the CUI and status register. WSM operation, internal verify and V_{PP} high voltage presence are monitored and reported via the RY/BY# output and appropriate status register bits. Figure 8, *Automated Byte Write Flowchart*, shows a system software flowchart for device byte write. The entire sequence is performed with V_{PP} at V_{PPH} . Byte write abort occurs when RP# transitions to V_{IL} , or V_{PP} drops to V_{PPL} . Although the WSM is halted, byte data is partially written at the location where byte write was aborted. Block erasure, or a repeat of byte write, is required to initialize this data to a known value.

7.0 AUTOMATED BLOCK ERASE

As above, the Quick-Erase algorithm of prior Intel Flash devices is now implemented internally, including all preconditioning of block data. WSM operation, erase success and V_{PP} high voltage presence are monitored and reported through RY/BY# and the status register. Additionally, if a command other than Erase Confirm is written to the device following Erase Setup, both the Erase status and Byte Write status bits will be set to "1"s. When issuing the Erase Setup and Erase Confirm commands, they should be written to an address within the address range of the block to be erased. Figure 6, *Automated Block Erase Flowchart*, shows a system software flowchart for block erase.

¹ Assumptions: 10-Kbyte file written every 10 minutes. (20-Mbyte array)/(10-Kbyte file) = 2,000 file writes before erase required.

$$(2000 \text{ files writes/erase}) \times (100,000 \text{ cycles per 28F008SA block}) = 200 \text{ million file writes.}$$

$$(200 \times 10^6 \text{ file writes}) \times (10 \text{ min/write}) \times (1 \text{ hr}/60 \text{ min}) = 33.3 \times 10^6 \text{ MTBF.}$$

Erase typically takes 1.6 seconds per block. The Erase Suspend/Erase Resume command sequence allows suspension of this erase operation to read data from a block other than that in which erase is being performed. A system software flowchart is shown in Figure 7, *Erase Suspend/Resume Flowchart*.

The entire sequence is performed with V_{PP} at V_{PPH} . Abort occurs when $RP\#$ transitions to V_{IL} or V_{PP} falls to V_{PPL} , while erase is in progress. Block data is partially erased by this operation, and a repeat of erase is required to obtain a fully erased block.

8.0 DESIGN CONSIDERATIONS

8.1 Three-Line Output Control

The 28F008SA will often be used in large memory arrays. Intel provides three control inputs to accommodate multiple memory connections. Three-line control provides for:

- a) lowest possible memory power dissipation
- b) complete assurance that data bus contention will not occur

To efficiently use these control inputs, an address decoder should enable $CE\#$, while $OE\#$ should be connected to all memory devices and the system's $READ\#$ control line. This assures that only selected memory devices have active outputs while deselected memory devices are in standby mode. $RP\#$ should be connected to the system $POWERGOOD$ signal to prevent unintended writes during system power transitions. $POWERGOOD$ should also toggle during system reset.

8.2 RY/BY# and Byte Write/Block Erase Polling

$RY/BY\#$ is a full CMOS output that provides a hardware method of detecting byte write and block erase completion. It transitions low time t_{WHRL} after a write or erase command sequence is written to the 28F008SA, and returns to V_{OH} when the WSM has finished executing the internal algorithm.

$RY/BY\#$ can be connected to the interrupt input of the system CPU or controller. It is active at all times, not tri-stated if the 28F008SA $CE\#$ or $OE\#$ inputs are brought to V_{IH} . $RY/BY\#$ is also V_{OH} when the device is in erase suspend or deep power-down modes.

8.3 Power Supply Decoupling

Flash memory power switching characteristics require careful device decoupling. System designers are interested in three supply current issues; standby current levels (I_{SB}), active current levels (I_{CC}) and transient peaks produced by falling and rising edges of $CE\#$. Transient current magnitudes depend on the device outputs' capacitive and inductive loading. Two-line control and proper decoupling capacitor selection will suppress transient voltage peaks. Each device should have a 0.1 μF ceramic capacitor connected between each V_{CC} and GND, and between its V_{PP} and GND. These high frequency, low inherent-inductance capacitors should be placed as close as possible to package leads. Additionally, for every eight devices, a 4.7 μF electrolytic capacitor should be placed at the array's power supply connection between V_{CC} and GND. The bulk capacitor will overcome voltage slumps caused by PC board trace inductances.

Table 4. Status Register Definitions

WSMS	ESS	ES	BWS	VPPS	R	R	R
7	6	5	4	3	2	1	0
					NOTES:		
SR.7 = WRITE STATE MACHINE STATUS 1 = Ready 0 = Busy					RY/BY# or the Write State Machine status bit must first be checked to determine byte write or block erase completion, before the Byte Write or Erase status bit are checked for success.		
SR.6 = ERASE SUSPEND STATUS 1 = Erase Suspended 0 = Erase in Progress/Completed							
SR.5 = ERASE STATUS 1 = Error in Block Erasure 0 = Successful Block Erase							
SR.4 = BYTE WRITE STATUS 1 = Error in Byte Write 0 = Successful Byte Write					If the Byte Write and Erase status bits are set to "1"s during a block erase attempt, an improper command sequence was entered. Attempt the operation again.		
SR.3 = V _{PP} STATUS 1 = V _{PP} Low Detect; Operation Abort 0 = V _{PP} OK					If V _{PP} low status is detected, the status register must be cleared before another byte write or block erase operation is attempted. The V _{PP} status bit, unlike an A/D converter, does not provide continuous indication of V _{PP} level. The WSM interrogates the V _{PP} level only after the byte write or block erase command sequences have been entered and informs the system if V _{PP} has not been switched on. The V _{PP} status bit is not guaranteed to report accurate feedback between V _{PPL} and V _{PPH} .		
SR.2–SR.0 = RESERVED FOR FUTURE ENHANCEMENTS					These bits are reserved for future use and should be masked out when polling the status register.		

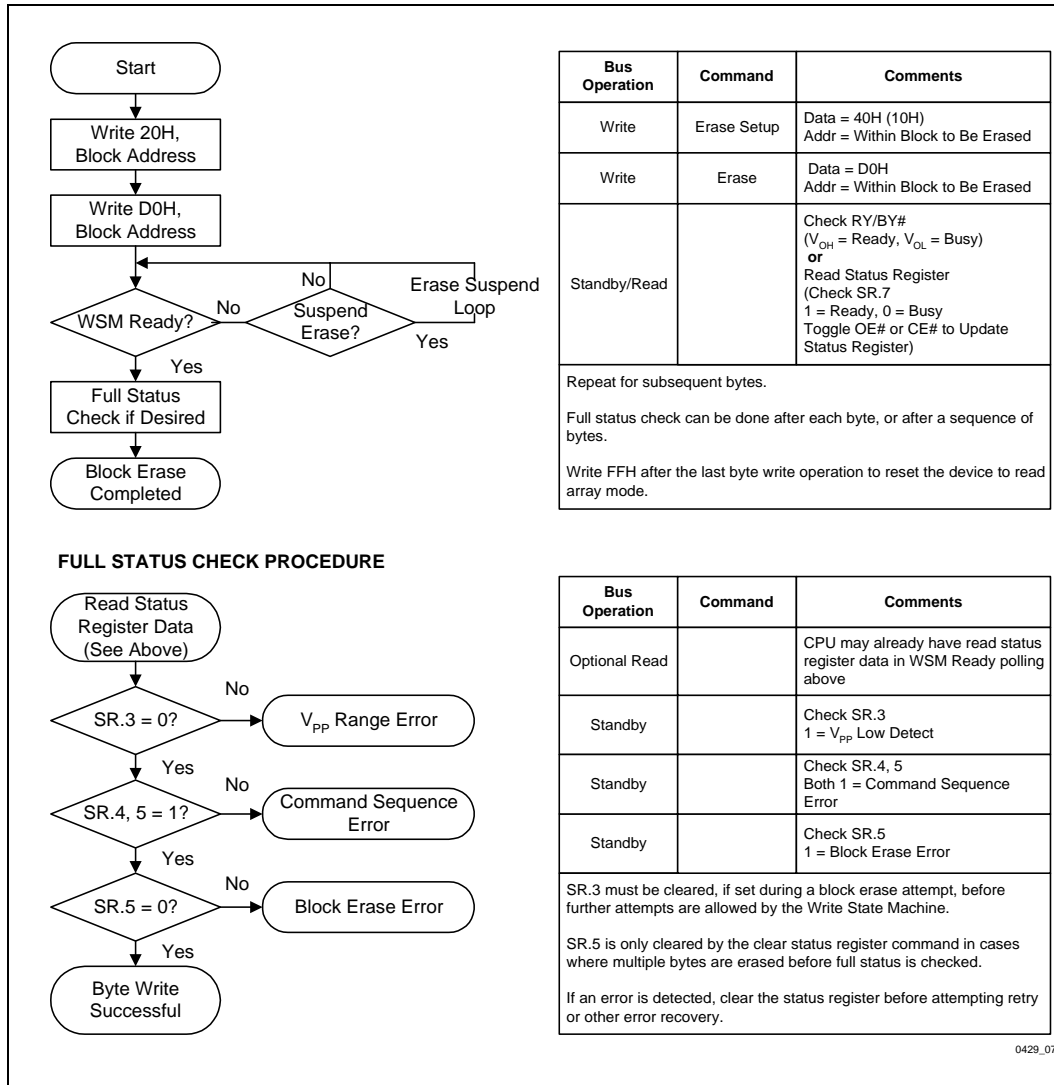
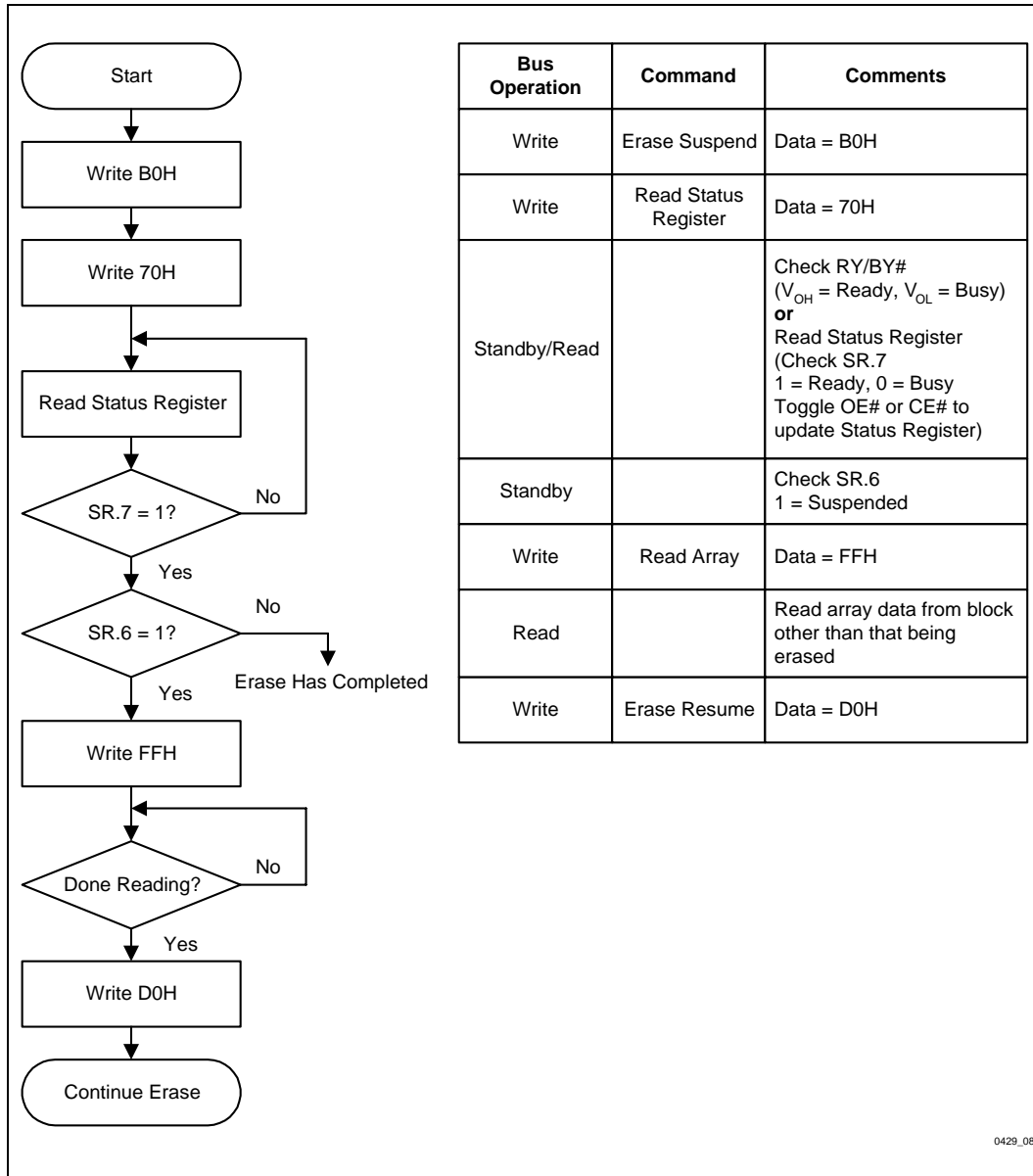

Figure 6. Automated Block Erase Flowchart



Bus Operation	Command	Comments
Write	Erase Suspend	Data = B0H
Write	Read Status Register	Data = 70H
Standby/Read		Check RY/BY# (V _{OH} = Ready, V _{OL} = Busy) or Read Status Register (Check SR.7 1 = Ready, 0 = Busy Toggle OE# or CE# to update Status Register)
Standby		Check SR.6 1 = Suspended
Write	Read Array	Data = FFH
Read		Read array data from block other than that being erased
Write	Erase Resume	Data = D0H

Figure 7. Erase Suspend/Resume Flowchart

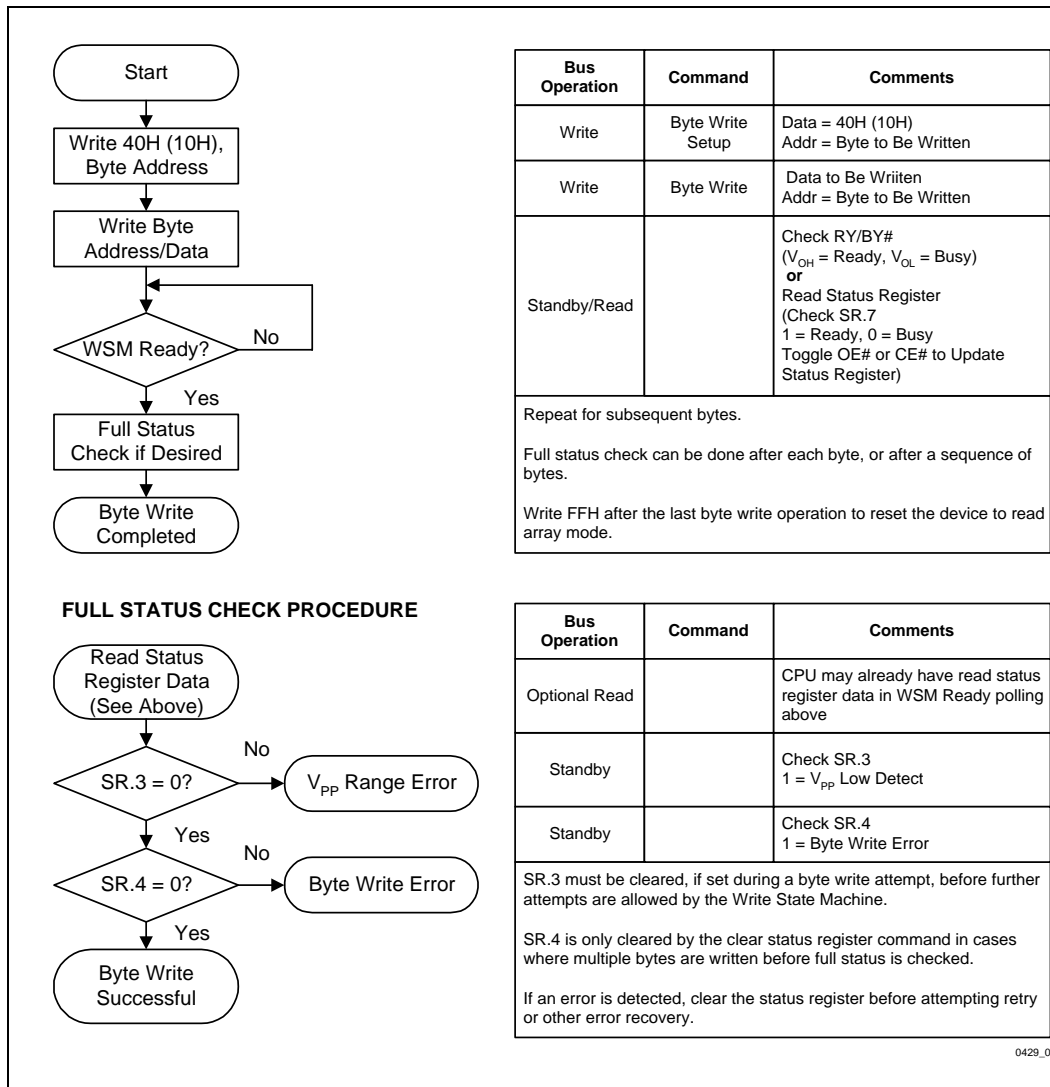

Figure 8. Automated Byte Write Flowchart

8.4 V_{PP} Trace on Printed Circuit Boards

Writing flash memories, while they reside in the target system, requires that the printed circuit board designer pay attention to the V_{PP} power supply trace. The V_{PP} pin supplies the memory cell current for writing and erasing. Use similar trace widths and layout considerations given to the V_{CC} power bus. Adequate V_{PP} supply traces and decoupling will decrease V_{PP} voltage spikes and overshoots.

8.5 V_{CC}, V_{PP}, RP# Transitions and the Command/Status Registers

Byte write and block erase completion are not guaranteed if V_{PP} drops below V_{PPH}. If the V_{PP} status bit of the status register (SR.3) is set to "1," a Clear Status Register command **must** be issued before further byte write/block erase attempts are allowed by the WSM. Otherwise, the byte write (SR.4) or erase (SR.5) status bits of the status register will be set to "1"s if error is detected. If RP# transitions to V_{IL} during byte write and block erase, RY/BY# will remain low until the reset operation is complete. Data is partially altered in either case, and the command sequence must be repeated after normal operation is restored. Device power-off, or RP# transitions to V_{IL}, clear the status register to initial value 10000 for the upper 5 bits.

The CUI latches commands as issued by system software and is not altered by V_{PP} or CE# transitions or WSM actions. Its state upon power-up, after exit from deep power-down or after V_{CC} transitions below V_{LKO}, is read array mode.

After byte write or block erase is complete, even after V_{PP} transitions down to V_{PLL}, the CUI must be reset to read array mode via the Read Array command if access to the memory array is desired.

8.6 Power Up/Down Protection

The 28F008SA is designed to offer protection against accidental block erasure or byte writing during power transitions. Upon power-up, the 28F008SA is indifferent as to which power supply, V_{PP} or V_{CC}, powers up first. Power supply sequencing is not required. Internal circuitry in the 28F008SA ensures that the CUI is reset to the read array mode on power-up.

A system designer must guard against spurious writes for V_{CC} voltages above V_{LKO} when V_{PP} is active. Since both WE# and CE# must be low for a command write, driving either to V_{IH} will inhibit writes. The CUI architecture provides an added level of protection since alteration of memory contents only occurs after successful completion of the two-step command sequences.

Finally, the device is disabled until RP# is brought to V_{IH}, regardless of the state of its control inputs. This provides an additional level of memory protection.

8.7 Power Dissipation

When designing portable systems, designers must consider battery power consumption not only during device operation, but also for data retention during system idle time. Flash nonvolatility increases usable battery life, because the 28F008SA does not consume any power to retain code or data when the system is off.

In addition, the 28F008SA's deep power-down mode ensures extremely low power dissipation even when system power is applied. For example, portable PCs and other power sensitive applications, using an array of 28F008SAs for solid-state storage, can lower RP# to V_{IL} in standby or sleep modes, producing negligible power consumption. If access to the 28F008SA is again needed, the part can again be read, following the t_{PHQV} and t_{PHWL} wakeup cycles required after RP# is first raised back to V_{IH}. See AC Characteristics—Read-Only and Write Operations and Figures 13 and 15 for more information.

9.0 ELECTRICAL SPECIFICATIONS

9.1 Absolute Maximum Ratings*

Operating Temperature

During Read..... 0 °C to +70 °C(1)

During Block Erase/Byte Write... 0 °C to +70 °C

Temperature Under Bias-10 °C to +80 °C

Storage Temperature-65 °C to +125 °C

Voltage on Any Pin

(except V_{CC} and V_{PP})

with Respect to GND..... -2.0 V to +7.0 V(2)

V_{PP} Program Voltage with

Respect to GND during

Block Erase/Byte Write-2.0 V to +14.0 V(2, 3)

V_{CC} Supply Voltage

with Respect to GND -2.0 V to +7.0 V(2)

Output Short Circuit Current 100 mA(4)

NOTICE: This datasheet contains preliminary information on new products in production. The specifications are subject to change without notice. Verify with your local Intel Sales office that you have the latest datasheet before finalizing a design.

**WARNING: Stressing the device beyond the "Absolute Maximum Ratings" may cause permanent damage. These are stress ratings only. Operation beyond the "Operating Conditions" is not recommended and extended exposure beyond the "Operating Conditions" may affect device reliability.*

NOTES:

1. Operating temperature is for commercial product defined by this specification.
2. Minimum DC voltage is -0.5 V on input/output pins. During transitions, this level may undershoot to -2.0 V for periods <20 ns. Maximum DC voltage on input/output pins is $V_{CC} + 0.5$ V which, during transitions, may overshoot to $V_{CC} + 2.0$ V for periods <20 ns.
3. Maximum DC voltage on V_{PP} may overshoot to +14.0 V for periods <20 ns.
4. Output shorted for no more than one second. No more than one output shorted at a time.
5. 5% V_{CC} specifications reference the 28F008SA-85 in its High Speed configuration. 10% V_{CC} specifications reference the 28F008SA-85 in its Standard configuration, and the 28F008SA-120.

9.2 Operating Conditions

Symbol	Parameter	Notes	Min	Max	Unit
T_A	Operating Temperature		0	70	°C
V_{CC}	V_{CC} Supply Voltage (10%)	5	4.50	5.50	V
V_{CC}	V_{CC} Supply Voltage (5%)	5	4.75	5.25	V

9.3 Capacitance(1)

$T_A = 25$ °C, $f = 1$ MHz

Symbol	Parameter	Typ	Max	Unit	Condition
C_{IN}	Input Capacitance	6	8	pF	$V_{IN} = 0$ V
C_{OUT}	Output Capacitance	8	12	pF	$V_{OUT} = 0$ V

NOTE:

1. Sampled, not 100% tested.

9.4 DC Characteristics

Symbol	Parameter	Notes	Min	Typ	Max	Unit	Test Condition
I _{LI}	Input Load Current	1			±1.0	μA	V _{CC} = V _{CC} Max V _{IN} = V _{CC} or GND
I _{LO}	Output Leakage Current	1			±10	μA	V _{CC} = V _{CC} Max V _{OUT} = V _{CC} or GND
I _{CCS}	V _{CC} Standby Current	1, 3		1.0	2.0	mA	V _{CC} = V _{CC} Max CE# = RP# = V _{IH}
				30	100	μA	V _{CC} = V _{CC} Max CE# = RP# = V _{CC} ±0.2 V
I _{CCD}	V _{CC} Deep Power-Down Current	1		0.20	1.2	μA	RP# = GND ±0.2 V I _{OUT} (R/Y/BY#) = 0 mA
I _{CCR}	V _{CC} Read Current	1		20	35	mA	V _{CC} = V _{CC} Max, CE# = GND f = 8 MHz, I _{OUT} = 0 mA CMOS Inputs
				25	50	mA	V _{CC} = V _{CC} Max, CE# = V _{IL} f = 8 MHz, I _{OUT} = 0 mA TTL Inputs
I _{CCW}	V _{CC} Byte Write Current	1		10	30	mA	Byte Write In Progress
I _{CCE}	V _{CC} Block Erase Current	1		10	30	mA	Block Erase In Progress
I _{CCES}	V _{CC} Erase Suspend Current	1, 2		5	10	mA	Block Erase Suspended CE# = V _{IH}
I _{PPS}	V _{PP} Standby Current	1		±1	±15	μA	V _{PP} ≤ V _{CC}
I _{PPD}	V _{PP} Deep Power-Down Current	1		0.10	5.0	μA	RP# = GND ±0.2 V
I _{PPR}	V _{PP} Read Current				200	μA	V _{PP} > V _{CC}
I _{PPW}	V _{PP} Byte Write Current	1		10	30	mA	V _{PP} = V _{PPH} Byte Write in Progress
I _{PPE}	V _{PP} Block Erase Current	1		10	30	mA	V _{PP} = V _{PPH} Block Erase in Progress
I _{PPES}	V _{PP} Erase Suspend Current	1		90	200	μA	V _{PP} = V _{PPH} Block Erase Suspended
V _{IL}	Input Low Voltage		-0.5		0.8	V	
V _{IH}	Input High Voltage		2.0		V _{CC} + 0.5	V	

9.4 DC Characteristics (Continued)

Symbol	Parameter	Notes	Min	Typ	Max	Unit	Test Condition
V _{OL}	Output Low Voltage	3			0.45	V	V _{CC} = V _{CC} Min I _{OL} = 5.8 mA
V _{OH1}	Output High Voltage (TTL)	3	2.4			V	V _{CC} = V _{CC} Min I _{OH} = -2.5 mA
V _{OH2}	Output High Voltage (CMOS)		0.85 V _{CC}			V	V _{CC} = V _{CC} Min I _{OH} = -2.5 μA
			V _{CC} - 0.4				V _{CC} = V _{CC} Min I _{OH} = -100 μA
V _{PPL}	V _{PP} during Normal Operations	4	0.0		6.5	V	
V _{PPH}	V _{PP} during Erase/Write Operations		11.4	12.0	12.6	V	
V _{LKO}	V _{CC} Erase/Write Lock Voltage		2.0			V	

NOTES:

1. All currents are in RMS unless otherwise noted. Typical values at V_{CC} = 5.0 V, V_{PP} = 12.0 V, T_A = 25 °C. These currents are valid for all product versions (packages and speeds).
2. I_{CCES} is specified with the device deselected. If the 28F008SA is read while in erase suspend mode, current draw is the sum of I_{CCES} and I_{CCR}.
3. Includes RY/BY#.
4. Block erases/byte writes are inhibited when V_{PP} = V_{PPL} and not guaranteed in the range between V_{PPH} and V_{PPL}.
5. Sampled, not 100% tested.

9.5 Extended Temperature Operating Conditions

Symbol	Parameter	Notes	Min	Max	Unit
T _A	Operating Temperature		-40	+85	°C
V _{CC}	V _{CC} Supply Voltage (10%)	5	4.50	5.50	V
V _{CC}	V _{CC} Supply Voltage (5%)	5	4.75	5.25	V

9.6 DC Characteristics—Extended Temperature Operation

Symbol	Parameter	Notes	Min	Typ	Max	Unit	Test Condition
I_{LI}	Input Load Current	1			± 1.0	μA	$V_{CC} = V_{CC} \text{ Max}$ $V_{IN} = V_{CC} \text{ or GND}$
I_{LO}	Output Leakage Current	1			± 10	μA	$V_{CC} = V_{CC} \text{ Max}$ $V_{OUT} = V_{CC} \text{ or GND}$
I_{CCS}	V_{CC} Standby Current	1, 3		1.0	2.0	mA	$V_{CC} = V_{CC} \text{ Max}$ $CE\# = RP\# = V_{IH}$
				30	100	μA	$V_{CC} = V_{CC} \text{ Max}$ $CE\# = RP\# = V_{CC} \pm 0.2 \text{ V}$
I_{CCD}	V_{CC} Deep Power-Down Current	1		0.20	20	μA	$RP\# = GND \pm 0.2 \text{ V}$ $I_{OUT} (RY/BY\#) = 0 \text{ mA}$
I_{CCR}	V_{CC} Read Current	1		20	35	mA	$V_{CC} = V_{CC} \text{ Max}$, $CE\# = GND$ $f = 8 \text{ MHz}$, $I_{OUT} = 0 \text{ mA}$ CMOS Inputs
				25	50	mA	$V_{CC} = V_{CC} \text{ Max}$, $CE\# = V_{IL}$ $f = 8 \text{ MHz}$, $I_{OUT} = 0 \text{ mA}$ TTL Inputs
I_{CCW}	V_{CC} Byte Write Current	1		10	30	mA	Byte Write In Progress
I_{CCE}	V_{CC} Block Erase Current	1		10	30	mA	Block Erase In Progress
I_{CCES}	V_{CC} Erase Suspend Current	1, 2		5	10	mA	Block Erase Suspended $CE\# = V_{IH}$
I_{PPS}	V_{PP} Standby Current	1		± 1	± 15	μA	$V_{PP} \leq V_{CC}$
I_{PPD}	V_{PP} Deep Power-Down Current	1		0.10	5.0	μA	$RP\# = GND \pm 0.2 \text{ V}$
I_{PPR}	V_{PP} Read Current				200	μA	$V_{PP} > V_{CC}$
I_{PPW}	V_{PP} Byte Write Current	1		10	30	mA	$V_{PP} = V_{PPH}$ Byte Write in Progress
I_{PPE}	V_{PP} Block Erase Current	1		10	30	mA	$V_{PP} = V_{PPH}$ Block Erase in Progress
I_{PPES}	V_{PP} Erase Suspend Current	1		90	200	μA	$V_{PP} = V_{PPH}$ Block Erase Suspended
V_{IL}	Input Low Voltage		-0.5		0.8	V	
V_{IH}	Input High Voltage		2.0		$V_{CC} + 0.5$	V	

9.6 DC Characteristics—Extended Temperature Operation (Continued)

Symbol	Parameter	Notes	Min	Typ	Max	Unit	Test Condition
V_{OL}	Output Low Voltage	3			0.45	V	$V_{CC} = V_{CC} \text{ Min}$ $I_{OL} = 5.8 \text{ mA}$
V_{OH1}	Output High Voltage (TTL)	3	2.4			V	$V_{CC} = V_{CC} \text{ Min}$ $I_{OH} = -2.5 \text{ mA}$
V_{OH2}	Output High Voltage (CMOS)		0.85 V_{CC}			V	$V_{CC} = V_{CC} \text{ Min}$ $I_{OH} = -2.5 \mu\text{A}$
			$V_{CC} - 0.4$				$V_{CC} = V_{CC} \text{ Min}$ $I_{OH} = -100 \mu\text{A}$
V_{PPL}	V_{PP} during Normal Operations	4	0.0		6.5	V	
V_{PPH}	V_{PP} during Erase/Write Operations		11.4	12.0	12.6	V	
V_{LKO}	V_{CC} Erase/Write Lock Voltage		2.0			V	

NOTES:

1. All currents are in RMS unless otherwise noted. Typical values at $V_{CC} = 5.0 \text{ V}$, $V_{PP} = 12.0 \text{ V}$, $T_A = 25 \text{ }^\circ\text{C}$. These currents are valid for all product versions (packages and speeds).
2. I_{CCES} is specified with the device deselected. If the 28F008SA is read while in erase suspend mode, current draw is the sum of I_{CCES} and I_{CCR} .
3. Includes RY/BY#.
4. Block erases/byte writes are inhibited when $V_{PP} = V_{PPL}$ and not guaranteed in the range between V_{PPH} and V_{PPL} .
5. Sampled, not 100% tested.

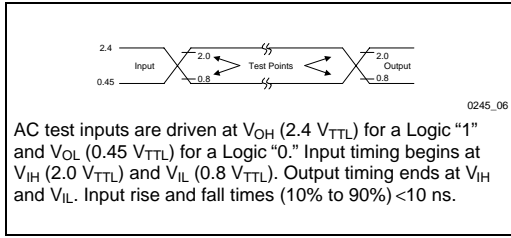

Figure 9. Testing Input/Output Waveform(1)

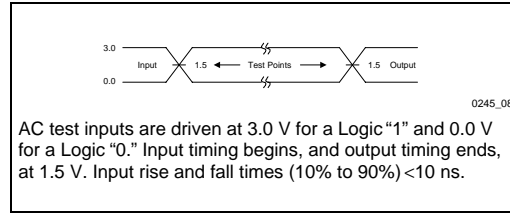

Figure 11. High Speed AC Testing Input/Output Waveforms(2)

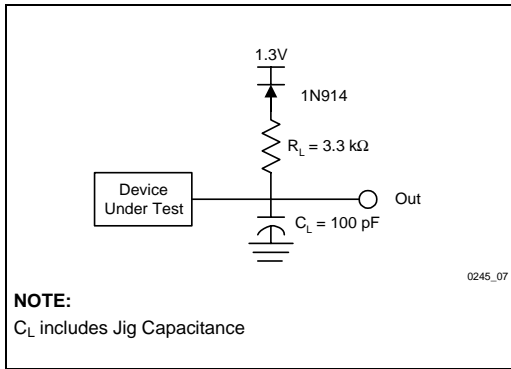

Figure 10. AC Testing Load Circuit(1)

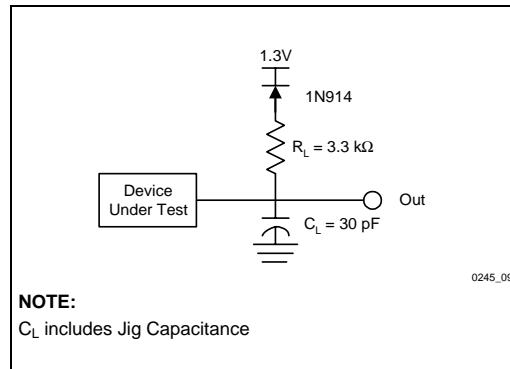

Figure 12. High Speed AC Testing Load Circuit(2)

NOTES:

1. Testing characteristics for 28F008SA-85 in Standard configuration, and 28F008SA-120.
2. Testing characteristics for 28F008SA-85 in High Speed configuration.

9.7 AC Characteristics—Read-Only Operations⁽¹⁾

Versions			V _{CC} ± 5%	28F008SA-85 ⁽⁴⁾		—		—		Unit
			V _{CC} ± 10%	—		28F008SA-85 ⁽⁵⁾		28F008SA-120 ⁽⁵⁾		
Symbol	Parameter	Notes	Min	Max	Min	Max	Min	Max		
t _{AVAV}	t _{RC}	Read Cycle Time		85		90		120	ns	
t _{AVQV}	t _{ACC}	Address to Output Delay			85		90		120	ns
t _{ELQV}	t _{CE}	CE# to Output Delay	2		85		90		120	ns
t _{PHQV}	t _{PWH}	RP# High to Output Delay			400		400		400	ns
t _{GLQV}	t _{OE}	OE# to Output Delay	2		40		45		50	ns
t _{ELQX}	t _{LZ}	CE# to Output Low Z	3	0		0		0		ns
t _{EHQZ}	t _{HZ}	CE# High to Output High Z	3		55		55		55	ns
t _{GLQX}	t _{OLZ}	OE# to Output Low Z	3	0		0		0		ns
t _{GHQZ}	t _{DF}	OE# High to Output High Z	3		30		30		30	ns
	t _{OH}	Output Hold from Addresses, CE# or OE# Change, Whichever is First	3	0		0		0		ns

NOTES:

1. See AC Input/Output Reference Waveform for timing measurements.
2. OE# may be delayed up to t_{CE}–t_{OE} after the falling edge of CE# without impact on t_{CE}.
3. Sampled, not 100% tested.
4. See High Speed AC Input/Output Reference Waveforms and High Speed AC Testing Load Circuits for testing characteristics.
5. See AC Input/Output Reference Waveforms and AC Testing Load Circuits for testing characteristics.

9.8 AC Characteristics—Read-Only Operations⁽¹⁾— Extended Temperature Operation

Versions		$V_{CC} \pm 10\%$	28F008SA-100 ⁽⁵⁾		Unit
Symbol	Parameter	Notes	Min	Max	
t_{AVAV}	t_{RC}	Read Cycle Time		100	ns
t_{AVQV}	t_{ACC}	Address to Output Delay			100
t_{ELQV}	t_{CE}	CE# to Output Delay	2		100
t_{PHQV}	t_{PWH}	RP# High to Output Delay			400
t_{GLQV}	t_{OE}	OE# to Output Delay	2		55
t_{ELQX}	t_{LZ}	CE# to Output Low Z	3	0	ns
t_{EHQZ}	t_{HZ}	CE# High to Output High Z	3		55
t_{GLQX}	t_{OLZ}	OE# to Output Low Z	3	0	ns
t_{GHQZ}	t_{DF}	OE# High to Output High Z	3		30
	t_{OH}	Output Hold from Addresses, CE# or OE# Change, Whichever is First	3	0	ns

NOTES:

1. See AC Input/Output Reference Waveform for timing measurements.
2. OE# may be delayed up to $t_{CE}-t_{OE}$ after the falling edge of CE# without impact on t_{CE} .
3. Sampled, not 100% tested.
4. See High Speed AC Input/Output Reference Waveforms and High Speed AC Testing Load Circuits for testing characteristics.
5. See AC Input/Output Reference Waveforms and AC Testing Load Circuits for testing characteristics.

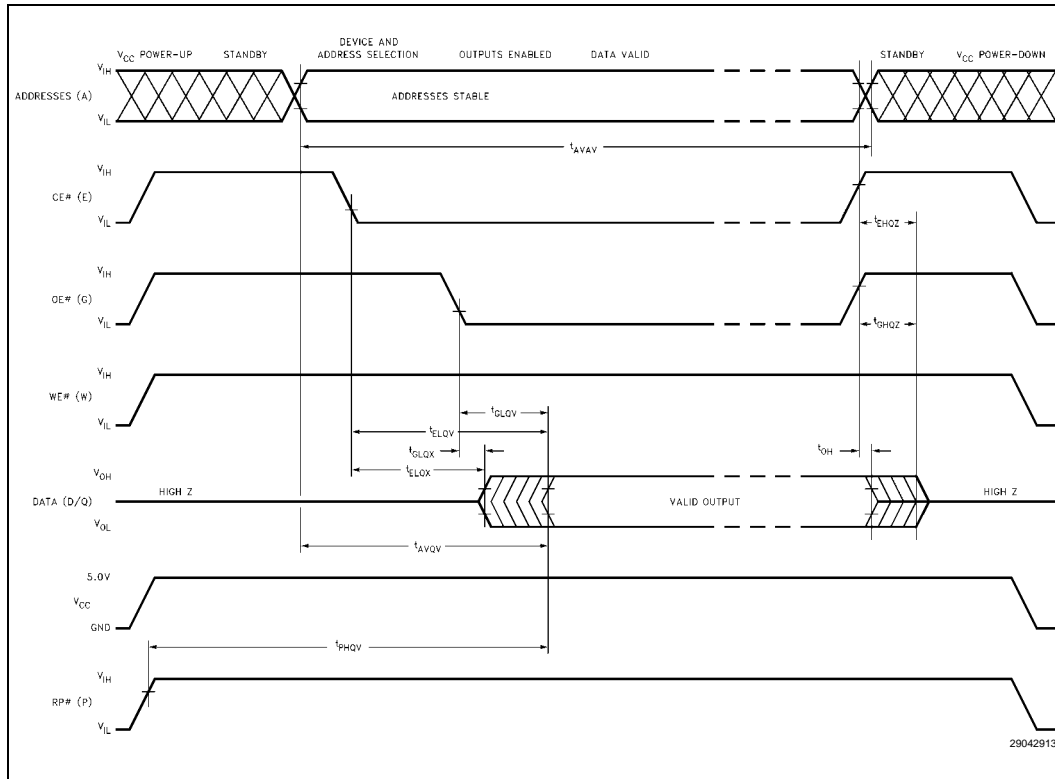

Figure 13. AC Waveform for Read Operations

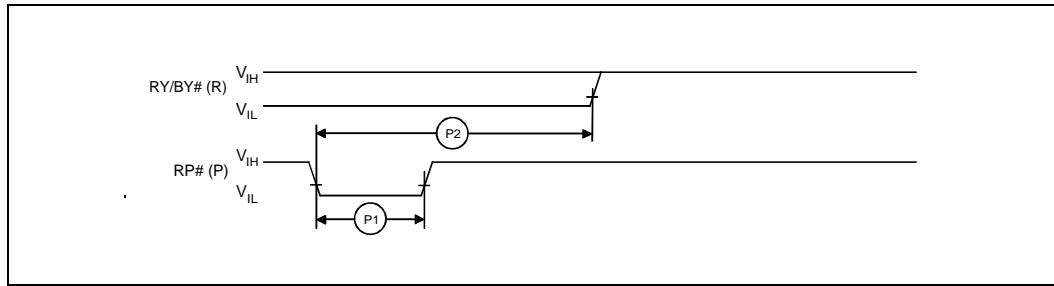

Figure 14. AC Waveform for Reset Operation

#	Sym	Parameter	Notes	Min	Max	Unit
P1	t _{PLPH}	RP# Pulse Low Time (If RP# is tied to V _{CC} , this specification is not applicable)		100		ns
P2	t _{PLRH}	RP# Low to Reset during Block Erase, Program, or Lock-Bit Configuration	2, 3		12	μs

NOTES:

1. These specifications are valid for all product versions (packages and speeds).
2. If RP# is asserted when the WSM is not busy (RY/BY# = "1"), the reset will complete within 100 ns.
3. A reset time, t_{PHQV}, is required from the latter of RY/BY# or RP# going high until outputs are valid.

9.9 AC Characteristics—Write Operations⁽¹⁾

Versions		V _{CC} ±5%	28F008SA–85 ⁽⁷⁾		—		—		Unit	
			V _{CC} ±10%		—		28F008SA–85 ⁽⁸⁾			28F008SA–120 ⁽⁸⁾
Symbol		Parameter	Notes	Min	Max	Min	Max	Min	Max	
t _{AVAV}	t _{WC}	Write Cycle Time		85		90		120		ns
t _{PHWL}	t _{PS}	RP# High Recovery to WE# Going Low	2	1		1		1		μs
t _{ELWL}	t _{CS}	CE# Setup to WE# Going Low		10		10		10		ns
t _{WLWH}	t _{WP}	WE# Pulse Width		40		40		40		ns
t _{VPWH}	t _{VPS}	V _{PP} Setup to WE# Going High	2	100		100		100		ns
t _{AVWH}	t _{AS}	Address Setup to WE# Going High	3	40		40		40		ns
t _{DVWH}	t _{DS}	Data Setup to WE# Going High	4	40		40		40		ns
t _{WHDX}	t _{DH}	Data Hold from WE# High		5		5		5		ns
t _{WHAX}	t _{AH}	Address Hold from WE# High		5		5		5		ns
t _{WHEH}	t _{CH}	CE# Hold from WE# High		10		10		10		ns
t _{WHWL}	t _{WPH}	WE# Pulse Width High		30		30		30		ns
t _{WHRL}		WE# High to RY/BY# Going Low			100		100		100	ns
t _{WHQV1}		Duration of Byte Write Operation	5, 6	6		6		6		μs
t _{WHQV2}		Duration of Block Erase Operation	5, 6	0.3		0.3		0.3		sec
t _{WHGL}		Write Recovery before Read		0		0		0		μs
t _{QVVL}	t _{VPH}	V _{PP} Hold from Valid SRD, RY/BY# High	2, 6	0		0		0		ns

NOTES:

1. Read timing characteristics during erase and byte write operations are the same as during read-only operations. Refer to *AC Characteristics—Read-Only Operations*.
2. Sampled, not 100% tested.
3. Refer to Table 3 for valid A_{IN} for byte write or block erasure.
4. Refer to Table 3 for valid D_{IN} for byte write or block erasure.
5. The on-chip Write State Machine incorporates all byte write and block erase system functions and overhead of standard Intel flash memory, including byte program and verify (byte write) and block precondition, precondition verify, erase and erase verify (block erase).
6. Byte write and block erase durations are measured to completion (SR.7 = 1, RY/BY# = V_{OH}). V_{PP} should be held at V_{PPH} until determination of byte write/block erase success (SR.3/4/5 = 0)
7. See High Speed AC Input/Output Reference Waveforms and High Speed AC Testing Load Circuits for testing characteristics.
8. See AC Input/Output Reference Waveforms and AC Testing Load Circuits for testing characteristics.

9.10 Block Erase and Byte Write Performance

Parameter	Notes	28F008SA-85		28F008SA-120		Unit
		Typ ⁽¹⁾	Max	Typ ⁽¹⁾	Max	
Block Erase Time	2	1.6	10	1.6	10	sec
Block Write Time	2	0.6	2.1	0.6	2.1	sec
Byte Write Time		8	(Note 3)	8	(Note 3)	μs

NOTES:

1. 25 °C, 12.0 V V_{PP} .
2. Excludes System-Level Overhead.
3. Contact your Intel representative for information on the maximum byte write specification.

9.11 AC Characteristics—Write Operations⁽¹⁾— Extended Temperature Operation

Versions		Parameter	Notes	28F008SA–100 ⁽⁸⁾		Unit
Symbol				Min	Max	
t _{AVAV}	t _{WC}	Write Cycle Time		100		ns
t _{PHWL}	t _{PS}	RP# High Recovery to WE# Going Low	2	1		μs
t _{ELWL}	t _{CS}	CE# Setup to WE# Going Low		10		ns
t _{WLWH}	t _{WP}	WE# Pulse Width		40		ns
t _{VPWH}	t _{VPS}	V _{PP} Setup to WE# Going High	2	100		ns
t _{AVWH}	t _{AS}	Address Setup to WE# Going High	3	40		ns
t _{DVWH}	t _{DS}	Data Setup to WE# Going High	4	40		ns
t _{WHDX}	t _{DH}	Data Hold from WE# High		5		ns
t _{WHAX}	t _{AH}	Address Hold from WE# High		5		ns
t _{WHEH}	t _{CH}	CE# Hold from WE# High		10		ns
t _{WHWL}	t _{WPH}	WE# Pulse Width High		30		ns
t _{WHRL}		WE# High to RY/BY# Going Low			100	ns
t _{WHQV1}		Duration of Byte Write Operation	5, 6	6		μs
t _{WHQV2}		Duration of Block Erase Operation	5, 6	0.3		sec
t _{WHGL}		Write Recovery before Read		0		μs
t _{QVVL}	t _{VPH}	V _{PP} Hold from Valid SRD, RY/BY# High	2, 6	0		ns

NOTES:

- Read timing characteristics during erase and byte write operations are the same as during read-only operations. Refer to *AC Characteristics—Read-Only Operations*.
- Sampled, not 100% tested.
- Refer to Table 3 for valid A_{IN} for byte write or block erasure.
- Refer to Table 3 for valid D_{IN} for byte write or block erasure.
- The on-chip WSM incorporates all byte write and block erase system functions and overhead of standard Intel flash memory, including byte program and verify (byte write) and block precondition, precondition verify, erase and erase verify (block erase).
- Byte write and block erase durations are measured to completion (SR.7 = 1, RY/BY# = V_{OH}). V_{PP} should be held at V_{PPH} until determination of byte write/block erase success (SR.3/4/5 = 0)
- See High Speed AC Input/Output Reference Waveforms and High Speed AC Testing Load Circuits for testing characteristics.
- See AC Input/Output Reference Waveforms and AC Testing Load Circuits for testing characteristics.

9.12 Block Erase and Byte Write Performance— Extended Temperature Operation

Parameter	Notes	28F008SA-100		Unit
		Typ ⁽¹⁾	Max	
Block Erase Time	2	1.6	10	sec
Block Write Time	2	0.6	2.1	sec
Byte Write Time		8	(Note 3)	μs

NOTES:

1. 25 °C, 12.0 V V_{PP}.
2. Excludes System-Level Overhead.
3. Contact your Intel representative for information on the maximum byte write specification.

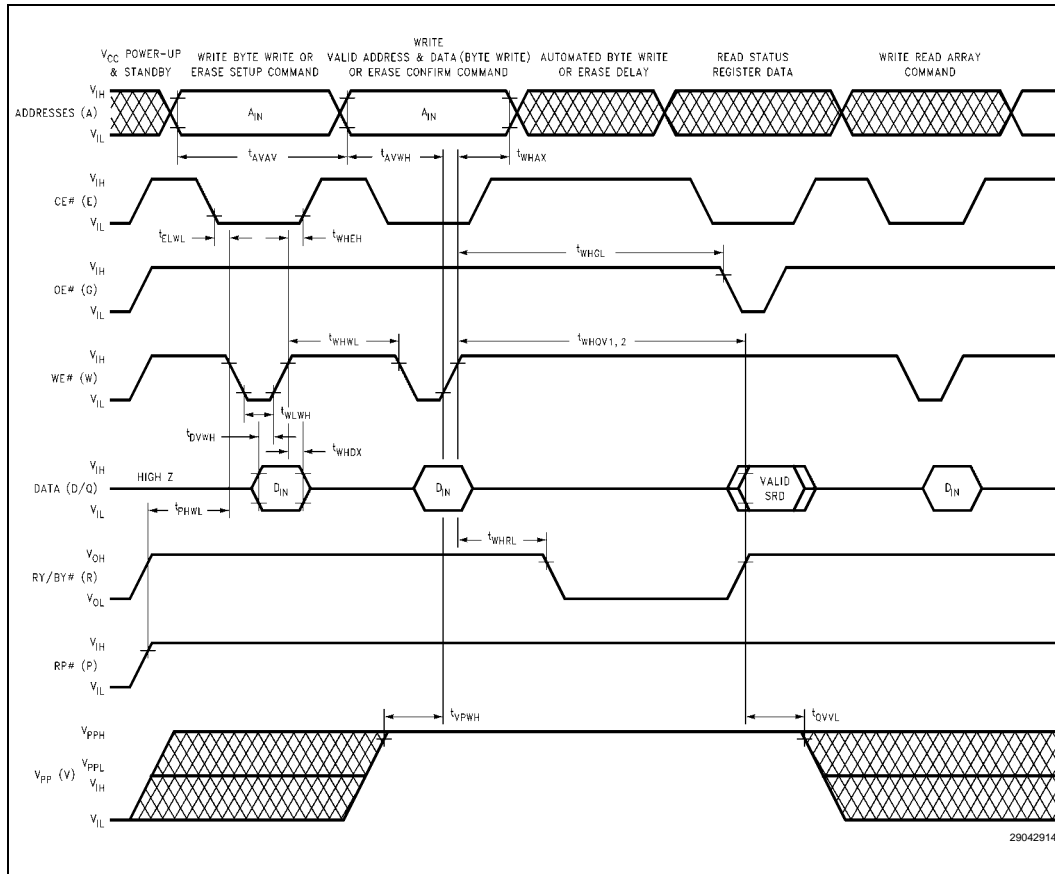

Figure 15. AC Waveform for Write Operations

9.13 Alternative CE#-Controlled Writes

Versions		V _{CC} ±5%		28F008SA–85 ⁽⁶⁾		—		—		Unit
		V _{CC} ±10%		—		28F008SA–85 ⁽⁷⁾		28F008SA–120 ⁽⁷⁾		
Sym		Parameter	Notes	Min	Max	Min	Max	Min	Max	
t _{AVAV}	t _{WC}	Write Cycle Time		85		90		120		ns
t _{PHEL}	t _{PS}	RP# High Recovery to CE# Going Low	2	1		1		1		μs
t _{WLEL}	t _{WS}	WE# Setup to CE# Going Low		0		0		0		ns
t _{ELEH}	t _{CP}	CE# Pulse Width		50		50		50		ns
t _{VPEH}	t _{VPS}	V _{PP} Setup to CE# Going High	2	100		100		100		ns
t _{AVEH}	t _{AS}	Address Setup to CE# Going High	3	40		40		40		ns
t _{DVEH}	t _{DS}	Data Setup to CE# Going High	4	40		40		40		ns
t _{EHDH}	t _{DH}	Data Hold from CE# High		5		5		5		ns
t _{EHAX}	t _{AH}	Address Hold from CE# High		5		5		5		ns
t _{EHWH}	t _{WH}	WE# Hold from CE# High		0		0		0		ns
t _{EHEL}	t _{EPH}	CE# Pulse Width High		25		25		25		ns
t _{EHRL}		CE# High to RY/BY# Going Low			100		100		100	ns
t _{EHQV1}		Duration of Byte Write Operation	5	6		6		6		μs
t _{EHQV2}		Duration of Block Erase Operation	5	0.3		0.3		0.3		sec
t _{EHGL}		Write Recovery before Read		0		0		0		μs
t _{QVVL}	t _{VPH}	V _{PP} Hold from Valid SRD, RY/BY# High	2, 5	0		0		0		ns

NOTES:

1. Chip-Enable Controlled Writes: Write operations are driven by the valid combination of CE# and WE#. In systems where CE# defines the write pulsewidth (within a longer WE# timing waveform), all setup, hold and inactive WE# times should be measured relative to the CE# waveform.
2. Sampled, not 100% tested.
3. Refer to Table 3 for valid A_{IN} for byte write or block erasure.
4. Refer to Table 3 for valid D_{IN} for byte write or block erasure.
5. Byte write and block erase durations are measured to completion (SR.7 = 1, RY/BY# = V_{OH}). V_{PP} should be held at V_{PPH} until determination of byte write/block erase success (SR.3/4/5 = 0)
6. See High Speed AC Input/Output Reference Waveforms and High Speed AC Testing Load Circuits for testing characteristics.
7. See AC Input/Output Reference Waveforms and AC Testing Load Circuits for testing characteristics.

9.14 Alternative CE#-Controlled Writes— Extended Temperature Operation

Versions		Parameter	$V_{CC} \pm 10\%$ Notes	28F008SA-100(7)		Unit
Symbol				Min	Max	
t_{AVAV}	t_{WC}	Write Cycle Time		100		ns
t_{PHEL}	t_{PS}	RP# High Recovery to CE# Going Low	2	1		μs
t_{WLEL}	t_{WS}	WE# Setup to CE# Going Low		0		ns
t_{ELEH}	t_{CP}	CE# Pulse Width		50		ns
t_{VPEH}	t_{VPS}	V_{PP} Setup to CE# Going High	2	100		ns
t_{AVEH}	t_{AS}	Address Setup to CE# Going High	3	40		ns
t_{DVEH}	t_{DS}	Data Setup to CE# Going High	4	40		ns
t_{EHDX}	t_{DH}	Data Hold from CE# High		5		ns
t_{EHAX}	t_{AH}	Address Hold from CE# High		5		ns
t_{EHWL}	t_{WH}	WE# Hold from CE# High		0		ns
t_{EHEL}	t_{EPH}	CE# Pulse Width High		25		ns
t_{EHRL}		CE# High to RY/BY# Going Low			100	ns
t_{EHQV1}		Duration of Byte Write Operation	5	6		μs
t_{EHQV2}		Duration of Block Erase Operation	5	0.3		sec
t_{EHGL}		Write Recovery before Read		0		μs
t_{QVVL}	t_{VPH}	V_{PP} Hold from Valid SRD, RY/BY# High	2, 5	0		ns

NOTES:

1. Chip-Enable Controlled Writes: Write operations are driven by the valid combination of CE# and WE#. In systems where CE# defines the write pulsewidth (within a longer WE# timing waveform), all setup, hold and inactive WE# times should be measured relative to the CE# waveform.
2. Sampled, not 100% tested.
3. Refer to Table 3 for valid A_N for byte write or block erasure.
4. Refer to Table 3 for valid D_N for byte write or block erasure.
5. Byte write and block erase durations are measured to completion (SR.7 = 1, RY/BY# = V_{OH}). V_{PP} should be held at V_{PPH} until determination of byte write/block erase success (SR.3/4/5 = 0)
6. See High Speed AC Input/Output Reference Waveforms and High Speed AC Testing Load Circuits for testing characteristics.
7. See AC Input/Output Reference Waveforms and AC Testing Load Circuits for testing characteristics.

10.0 ORDERING INFORMATION

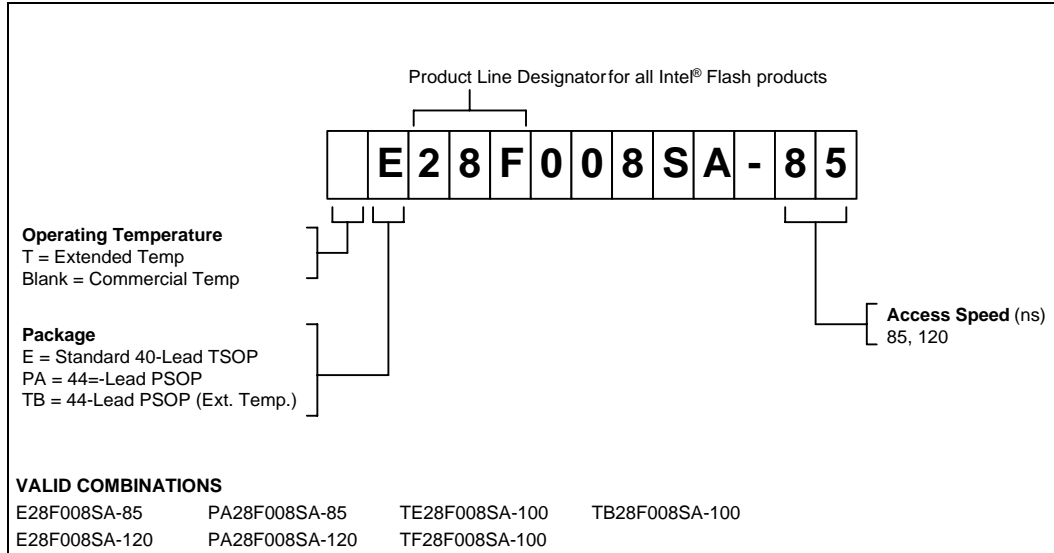

11.0 ADDITIONAL INFORMATION

Order Number	Document/Tool
290597	5 Volt FlashFile™ Memory; 28F004S5, 28F008S5, 28F016S5 datasheet
290598	3 Volt FlashFile™ Memory; 28F004S3, 28F008S3, 28F016S3 datasheet
271296	28F008SA 8-Mbit (1-Mbit x 8) Flash Memory SmartDie™ Product Specification
292180	AP-625 28F008SC Compatibility with 28F008SA
297183	28F008 SA/SA-L Specification Update
Note 3	AP-359 28F008SA Hardware Interfacing
Note 3	AP-364 28F008SA Automation and Algorithms

NOTES:

- Please call the Intel Literature Center at (800) 548-4725 to request Intel documentation. International customers should contact their local Intel or distribution sales office.
- Visit Intel's World Wide Web home page at <http://www.intel.com> for technical documentation and tools.
- These documents can be located at the Intel World Wide Web support site, <http://www.intel.com/support/flash/memory>